

Low frequency machinery monitoring: measurement considerations

Wilcoxon Research, Inc.
Richard M. Barrett Jr., Senior Application Engineer

Low frequency monitoring of industrial machinery requires specialized sensors, instrumentation and measurement techniques. The primary goal when measuring low frequency vibrations is to minimize electronic noise from the sensor and monitoring instrument. The sensor must contain low noise electronics to provide clean vibration signals and high output to overcome instrument noise. The impact of environmental and near machine electrical and mechanical noise can also effect low frequency measurements. In addition, sensor settling time, instrument setup and processing time must be considered. Finally, proper sensor handling and mounting techniques will help ensure quality measurements are made.

Introduction to low frequency measurements

Low frequency vibration monitoring is an integral part of the total predictive maintenance program. Failure of slow speed machinery can result in catastrophic machine damage, lost production, and worker safety hazards. New generations of sensors, instruments, and analysis techniques are available for low frequency measurements.

Low frequency condition monitoring generally requires measurements within a 0.1 to 10 Hz (6 to 600 cpm) bandwidth. Applications include paper machines, cooling towers and slow speed agitators. Gear boxes, compressors and other higher speed machinery may also exhibit faults in this region. Many structural and geophysical measurements require very low frequency equipment and techniques.

Low frequency applications are more complicated than general machinery monitoring. The relationship between acceleration, velocity, and displacement with respect to vibration amplitude and machinery health redefines measurement technique and data analysis. Motion below 10 Hz (600 cpm) produces very little vibration in terms of acceleration, moderate vibration in terms of velocity, and relatively large vibrations in terms of displacement (Figure 1). Measurement of the low acceleration amplitudes at slow

Wilcoxon Research
21 Firstfield Road
Gaithersburg
MD 20878
USA

Tel: +1 (301) 330 8811
Fax: +1 (301) 330 8873

www.wilcoxon.com
www.meggitt.com



speeds requires special sensor designs and low noise electronics.

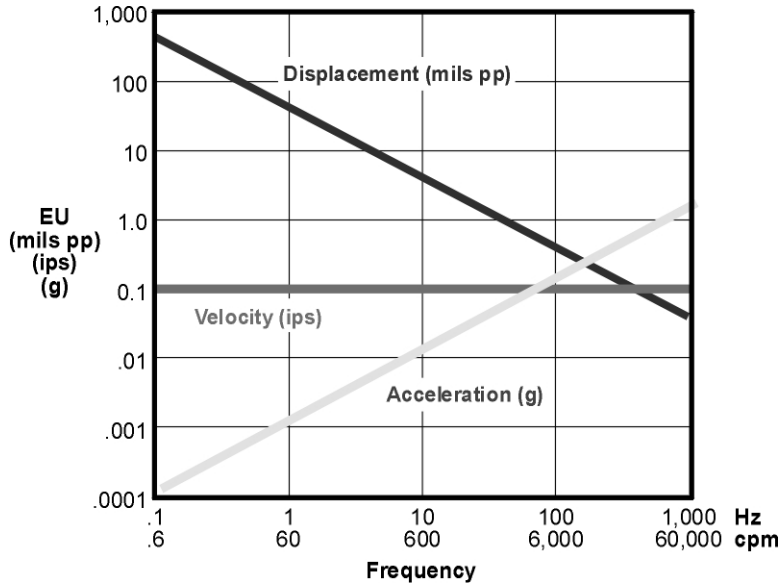

Figure 1. Relationship between displacement, velocity, and acceleration, at constant velocity

Low frequency readings are generally expressed in terms of velocity (inches per second), or displacement (mils peak to peak). Accelerometer measurements are electrically integrated or converted by software. Vibration can be measured with velocity sensors and proximity probes; however these devices lack the versatility of piezoelectric accelerometers (Figure 2).

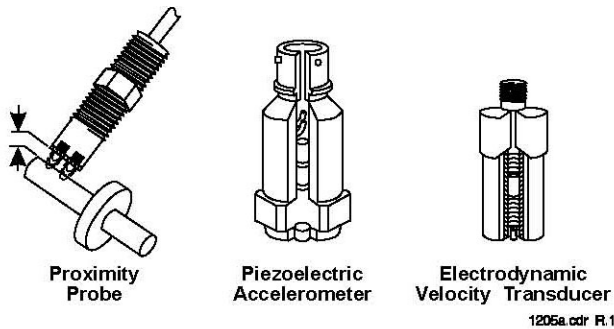

Figure 2. Sensor types



An example pump measurement is shown in Figure 3. An accelerometer output is displayed in terms of acceleration, velocity, and displacement. The displacement plot exhibits the strongest low frequencies, but attenuates the spectrum above 10,000 cpm (167 Hz). The acceleration display provides the broadest frequency range.

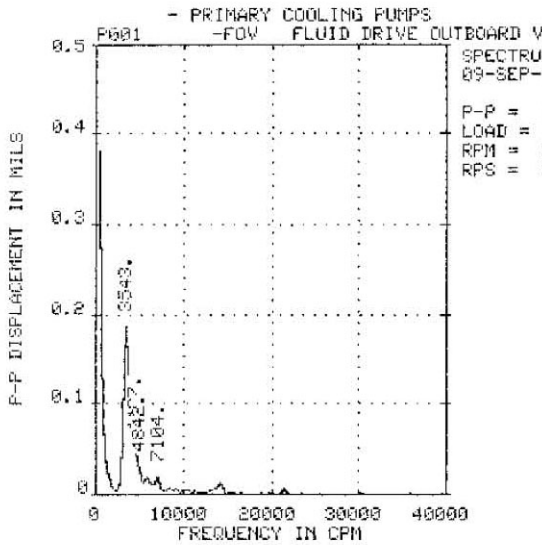

Figure 3a. Accelerometer double integrated to displacement

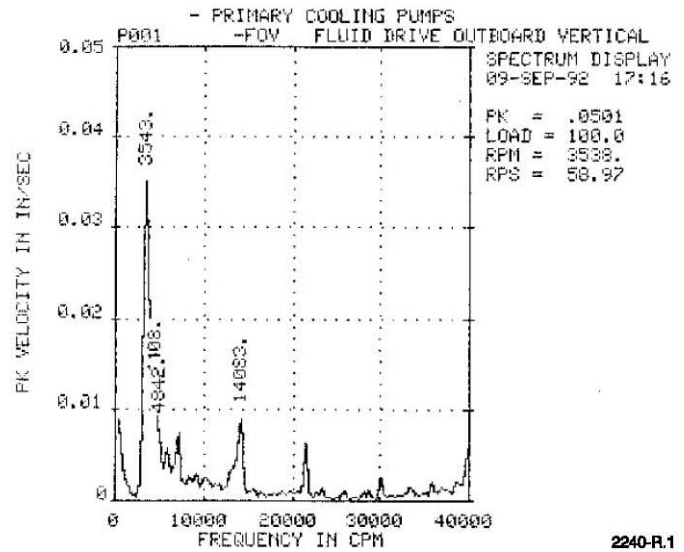

Figure 3b. Accelerometer double integrated to velocity

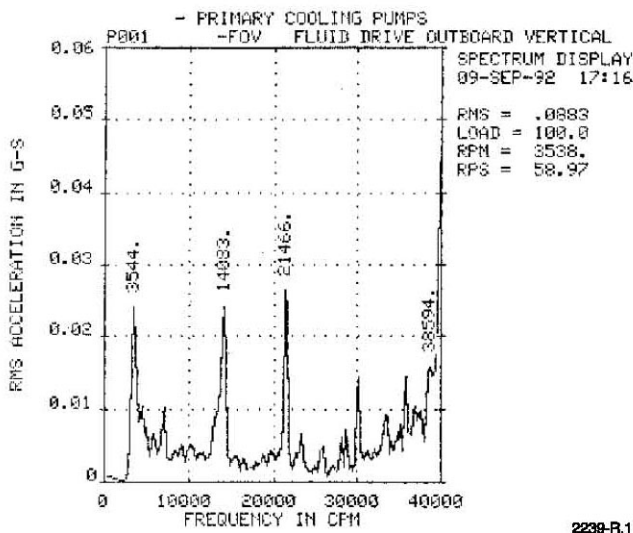

Figure 3c. Accelerometer double integrated to acceleration

2240-R.1

2239-R.1

Low frequency measurement equipment

Sensors at low frequency

Piezoceramic accelerometers are used for most low frequency measurement applications. If properly selected, they generate sufficient signal strength for very low amplitude use and integration to velocity or displacement. Compared to other sensors, accelerometers exhibit the broadest dynamic range in terms of frequency and amplitude. The solid state accelerometer design is extremely rugged and easy to install. Internal electronics reduce cabling concerns and provide a variety of outputs and filter options.

Proximity (eddy current) probes produce strong low frequency displacement outputs down to DC (0 Hz). They are non-contacting devices used to measure relative motion between rotating shafts and bearing housings. Proximity probes cannot perform absolute seismic measurements and are very limited at higher frequencies. They are difficult to install in retrofit applications and require specialized matched cables and driving electronics (Figure 4).

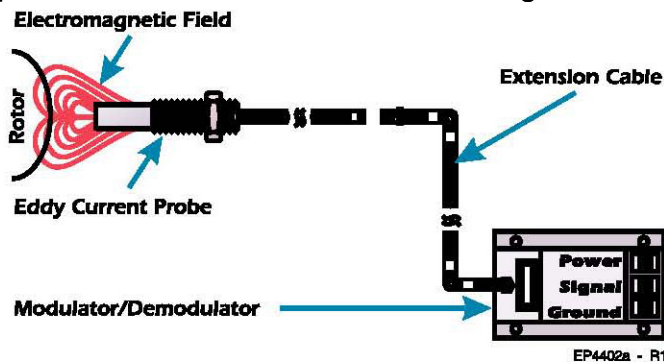

Figure 4. Eddy current transducer

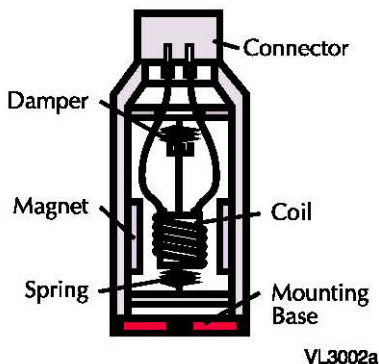

Figure 5. Basic construction of electrodynamic velocity pick-up

Electrodynamic velocity sensors also provide strong outputs at low frequency, however, the sensitivity is not linear below the natural frequency of the sensor. Below resonance, typically 8 to 14 Hz (480 to 840 cpm), the signal is increasingly attenuated and sensitivity reduced. Electrodynamic pickups are sensitive to mounting orientation and contain moving parts that are prone to wear and fatigue (Figure 5).



Piezovelocity transducers (PVT) are low frequency accelerometers with internal integration. They exhibit much broader frequency ranges compared to electrodynamic pickups (Figure 6). However, they do not measure as low in frequency or amplitude as most low frequency accelerometers. Because of the increasing amplifier gain required for low frequency integration, PVTs are usually filtered at 1.5 Hz (90 cpm); below the filter corner frequency, the output is attenuated and sensitivity lowered.

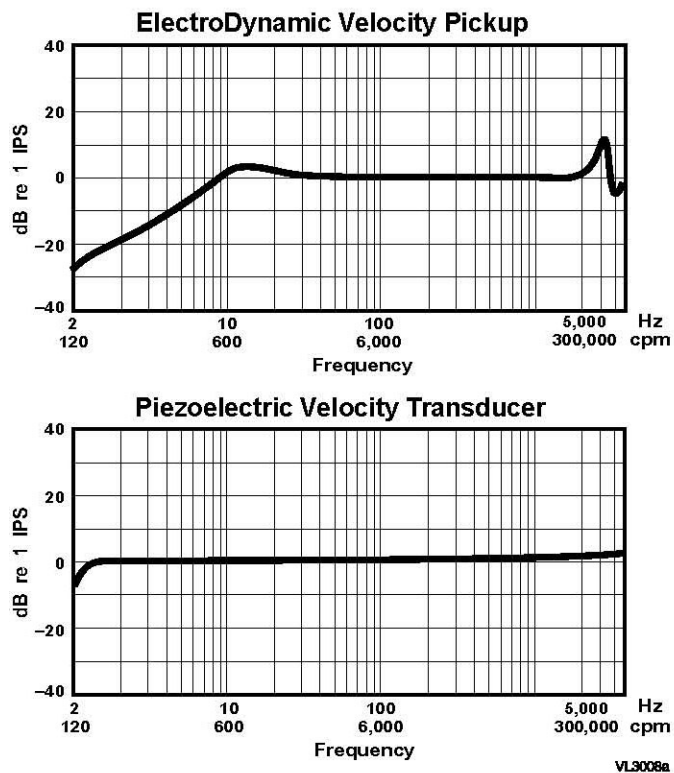

Figure 6. Comparison of velocity sensor response characteristics

PVTs provide very strong voltage outputs to the monitoring instrument. In the 1.5 to 12 Hz (90 to 720 cpm) frequency band, a 100 mV/ips velocity sensor provides higher voltage outputs than 500 mV/g accelerometers. PVTs optimize performance in many low frequency applications.¹

System selection criteria

Selection of low frequency sensors and instrumentation requires frequency content and vibration amplitude information. The minimum frequency is determined to ensure that low end filtering of the sensor and monitoring instrument are suitable for the application. Machine vibration alarm levels and



low amplitude measurement requirements are specified to benchmark the electronic noise characteristics of the measurement system (refer to insert). Sensor output sensitivity is selected to optimize the signal voltage to the monitoring instrument. All other system characteristics such as environment, cabling, and powering are then evaluated as shown in Table 1.

Table 1. Low frequency system selection criteria

Select:	Based upon:
Frequency response	Machine speed
Amplitude requirements	Alarm limits
Sensitivity	Data collection range
Cabling, powering, etc.	Environment

Low frequency accelerometers

Low frequency accelerometers minimize electronic noise and maximize voltage output to the monitoring instrument. The sensing element contains a piezoceramic crystal driven by a large seismic mass. An internal amplifier conditions the charge signal from the sensing element and provides a standardized voltage output. The charge output from the sensing element and amplifier design determine the electronic noise and low frequency response. Figures 7a, b, and c show typical low frequency accelerometer designs. Compression and shear mode accelerometers are most common in industrial applications; bender modes are very fragile and reserved for specialized seismic testing.

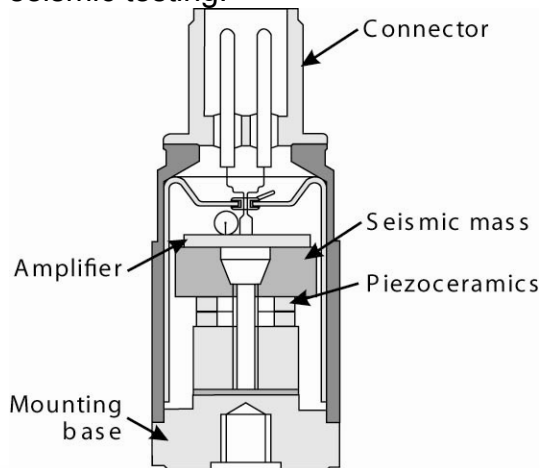

2339a

Figure 7a. Compression mode low frequency accelerometer design

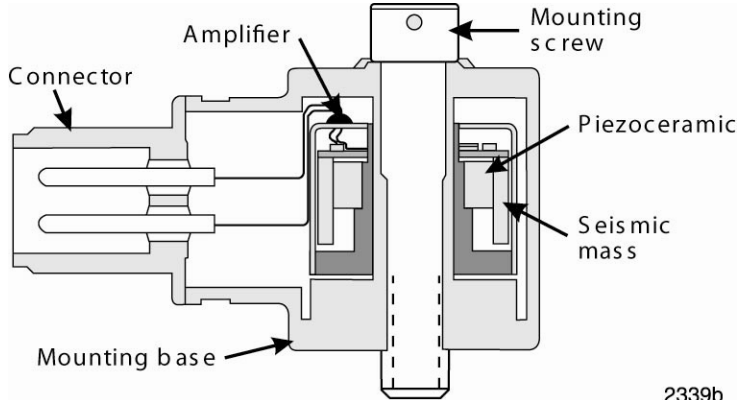

Figure 7b. Shear mode low frequency accelerometer design 2339b

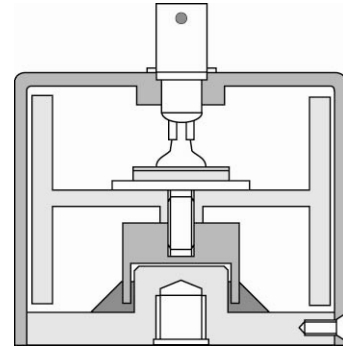

Figure 7c. Bender mode low frequency accelerometer design

Piezoelectric sensors use high pass filters to remove DC and near DC signals (Figure 8). Filtering eliminates low frequency transients from thermal expansion of the sensor housing. The filter corner frequency defines the point at which the sensitivity is attenuated to 71% (-3dB) of the calibrated sensitivity (500 mV/g, 100 mV/ips, etc.). Below the corner frequency of a single pole filter, the signal will be reduced by half every time the frequency is halved. If a 2 pole filter is used, it will be reduced to one fourth every time the frequency is cut in half.

Low frequency accelerometers cannot be selected on response alone. Widening the filter of a general purpose sensor does not create a low frequency accelerometer. Many sensors that appear to measure low frequencies are unusable in slow speed applications because of excessive electronic noise. This is especially true with many quartz accelerometers.

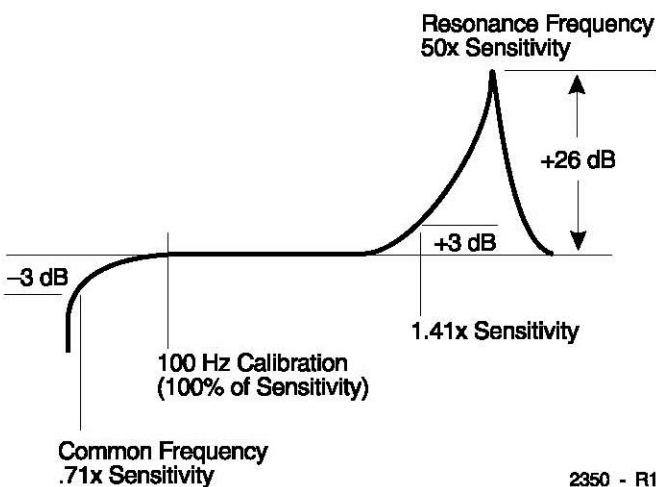

Figure 8. Typical accelerometer frequency response without high frequency filtering



Low frequency accelerometers are susceptible to high frequency overload and may contain low pass filters to attenuate high frequency signals. High frequency overload can be caused by mechanical or electrical signal sources. Low frequency accelerometers must contain overload protection circuits to damp oscillations and prevent amplifier damage. In some cases mechanical filters can be placed beneath the sensor to eliminate high frequency signals.² Velocity sensors are inherently filtered at high frequency and are less susceptible to overload.

Monitoring instruments

Monitoring instrument selection is similar to the sensor in terms of response and electronic noise. The design of the signal input determines the frequency response of the monitor and may affect further signal processing considerations. Once the instrument is chosen the measurement system can be evaluated.

Most piezoelectric accelerometers output a DC bias voltage to carry the AC vibration signal. The monitor must remove the DC bias voltage before measuring the AC vibration signal (see Figure 9). Two types of input circuitry are used to remove DC signals - filtering and differential cancellation.

When using filtered inputs, the analyst must determine the corner frequency and number filter poles. Instrument and sensor filters can then be considered as a system. For example, if using a sensor and instrument with identical corner frequencies, a vibration signal of 10 mils pp at the corner frequency would measure only 5 mils pp ($71\% \text{ of } 71\% = 50\%$). In certain applications alarms should be set to compensate for amplitude error.

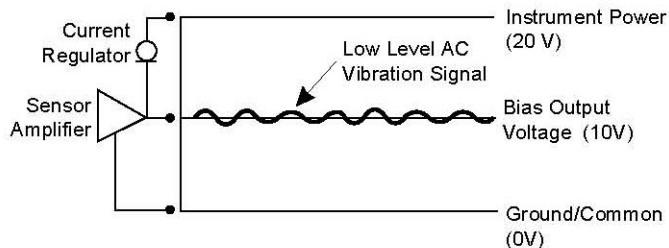



Figure 9. Removing DC bias voltage

Many instruments utilize direct coupled differential inputs. Differential inputs read the sensors bias output voltage and subtract it from the signal. This allows measurements down to 0 Hz and eliminates the monitor's contribution to low



frequency signal attenuation. However, differential inputs must take accelerometer readings in terms of acceleration. Analog integration in the data collector will introduce AC coupling (filtering) and contribute to very low frequency signal attenuation. Signal integration using differential inputs can be performed digitally or by software during analysis.³

One advantage of using analog integration is the inherent attenuation of high frequency signals. This can improve low frequency signal to noise ratio by preventing high amplitude, high frequency signals using up the dynamic range of the instrument. Trade-offs between low frequency response and instrument noise determine the integration method used.

System noise considerations

Signal to noise ratio

Signal noise is the primary consideration when performing low frequency measurements.⁴ Noise can obscure spectral data, alter amplitude information and render measurements useless. When integrated, low frequency noise is amplified to produce the familiar “ski slope” response.

The first law of low frequency analysis is to “maximize the signal to noise ratio of the vibration measurement”. The vibration signal is analogous to a ship on an ocean, where sea level is equivalent to the noise floor of the measurement. The higher the ship rides in the water the more information about it will be available and the easier it is to detect on the horizon - submerged ships go undetected.

The second law is that “post processing cannot reproduce signals that were not recorded in the first place.”⁵ To continue the analogy, if a picture is taken of the sea once the ship is submerged, no amount of photographic enhancement will reproduce its image.

Signal noise results from a combination of three sources: sensor electronic noise, instrument electronic noise and environmental noise (refer to Figure 9). The electronic noise of the sensor is directly related to the charge output of the piezoelectric sensing element and amplifier design. The instrument noise is determined by electronic design, integration method, and the voltage input from the sensor. Environmental noise can result from a variety of external sources, electrical and mechanical in nature.

Sensor noise

All amplifiers contain a variety of electronic noise sources including resistors, diodes, and transistors. Resistors create Johnson (white) noise - this is the familiar “crackle” on a low-fidelity stereo system. Johnson noise governs the high frequency noise floor of the measurement. Transistors and other active devices produce Schottky ($1/f$) noise. Schottky noise increases with decreasing frequency and determines the low frequency measurement limit as demonstrated in Figure 10. The low frequency noise of an accelerometer is proportional to the gain (amplification) of the circuit and inversely proportional to the charge sensitivity of the piezoelectric sensing element.^{6,7}

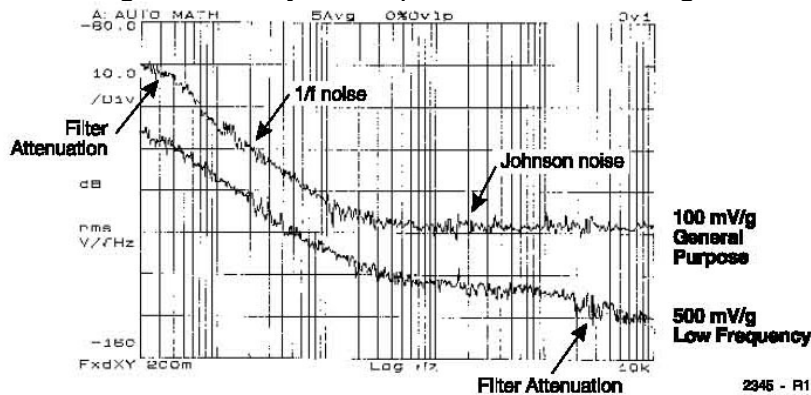

Figure 10. Noise plot of 100 mV/g and 500 mV/g sensors

Increasing gain to increase the voltage sensitivity will reduce the contribution of instrument noise, but will not change the signal to noise ratio at the sensor. Returning to our analogy above - if the ship were in a canal, increasing the water level in a lock will make it easier to view from the levee, however, the amount of ship that can be seen above the water remains unchanged.

Increasing the charge output of the sensing element (output before the amplification) reduces the need for gain and increases signal to noise. The charge sensitivity can only be increased by adding more seismic mass or using a more active sensing material. In low frequency applications piezoceramics should be used to maximize the charge output of the sensing assembly.

Modern piezoceramic materials are specifically designed for accelerometers applications. The charge output of Lead Zirconate-Titanate (PZT) is 150 times higher than quartz as shown in Table 2. This enables piezoceramic sensors to provide strong low amplitude signals while retaining the ruggedness and wide frequency range required in industrial applications. Low frequency quartz accelerometers require excessively large seismic masses and/or bender mode



design configurations; and therefore exhibit very low resonances and inherent fragility.

Table 2. Piezoelectric sensitivity comparison

Piezoelectric material	Charge per unit force in pc/N (compression)
Lead Zirconate Titanate (PZT)	350
Lithium Niobate	21
Polyvinylidene Flouride (PVDF)	22
Quartz	2.2

Instrument noise

Instrument contribution to system noise depends on electronic design, dynamic range and set up. Instrument components create both Johnson and Schottky noise as described above. Dynamic range considerations require matching the sensor output with instrument processing requirements. Set up factors to be considered are integration, resolution, and averaging.

Analog integration within the monitoring instrument usually increases low frequency noise and lowers signal to noise. The integration circuit converts acceleration to velocity by amplifying low frequency signals and attenuating high frequencies. Low frequency gain also amplifies and accentuates low frequency noise of both the accelerometer and instrument. Double integration from acceleration to displacement requires more amplification and introduces more noise. Integration of low frequency noise is the primary cause of “ski slope”.

Piezovelocity transducers (internally integrated accelerometers) and higher sensitivity (500mV/g) accelerometers significantly improve low frequency response by presenting a higher voltage output to the monitor input. Higher input voltage improves signal to noise by reducing the monitor noise contribution. PVTs provide additional improvement in dynamic range by attenuating high frequency signals before the instrument input. Table 3 tabulates equivalent voltage outputs for various sensors excited by a constant 0.3 ips vibration; Figure 11 provides a graphical sensor comparison.



Table 3. Relationship between displacement, velocity, and acceleration with vibration sensor output levels

	1.5 Hz (90 cpm)	10 Hz (600 cpm)	100 Hz (6,000 cpm)	10,000 Hz (60,000cpm)
Displacement(mils)	32	5	.5	.5
Velocity (ips)	.3	.3	.3	.3
Acceleration (g)	.007	.05	.5	.5
100 mV/g Accelerometer (V)	.0007	.005	.05	.5
500 mV/g Accelerometer (V)	.0035	.025	.25	2.5
100mV/ips Piezovelocity transducer (V)	.03	.03	.03	.03

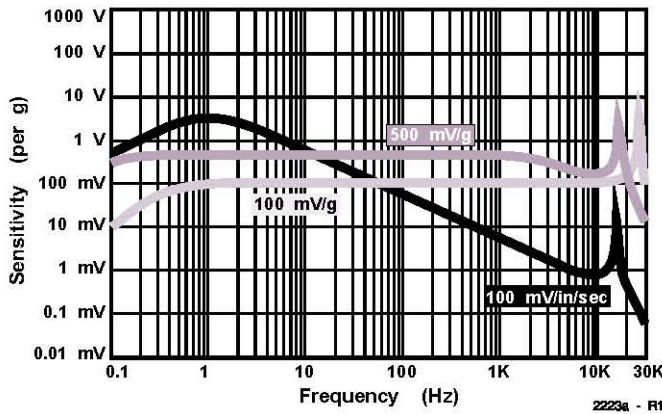

Figure 11. Frequency response for standard, low frequency, and piezovelocity transducers

Finer instrument resolution improves signal fidelity by reducing spectral amplifier noise. Since electronic amplifier noise is random in nature, spectral sensor noise is determined by measuring the average power of the noise over a specified bandwidth. Spectral amplifier noise is written in terms of volts (or equivalent units) per square root of the measured frequency band; the frequency band used for most specification tests is 1 Hz. If resolution is increased so that the linewidth (measured band) is less than 1 Hz, noise will decrease.⁸



For example, given a sensor with a specified spectral noise of 2.0 $\mu\text{g}/\sqrt{\text{Hz}}$ at 2 Hz, and an instrument setup for 1600 lines of resolution over a 0 to 10 Hz (0 to 600 cpm) bandwidth, the linewidth of the measurement is:

$$(10\text{Hz} - 0\text{Hz})/1600 \text{ lines} = .00625\text{Hz} (.375 \text{ cpm})$$

The spectral noise improvement of the sensor is:

$$(2.0\mu\text{g}/\sqrt{\text{Hz}})(.00625\text{Hz})^{1/2} = .158\mu\text{g}$$

The trade-off is increased data collection time. An example is given in Table 4.

Table 4. Resolution effects using a 0-10Hz bandwidth

Lines of resolution	400	800	1600	3200
Electronic spectral noise of a low frequency sensor (1 $\mu\text{g}/\sqrt{\text{Hz}}$)	0.16 μg	0.08 μg	0.04 μg	0.02 μg
Measurement time per data set	40 sec	80 sec	160 sec	320 sec
Measurement time for four (4) averages without overlapping	160 sec	320 sec	640 sec	1,280 sec
Measurement time for eight (8) averages without overlapping	320 sec	640 sec	1,280 sec	2,560 sec

Increased averaging lowers noise by smoothing out random noise signals. Over time the random noise contribution is reduced and periodic signals strengthened. Like resolution increases, the down side of increased averaging is longer data collection time. Synchronous time averaging further increases signal to noise by eliminating any signals not harmonically related to the trigger frequency (usually the running speed of the machine).

Environmental noise

Environmental noise can be caused by any external signal that directly or indirectly interferes with the measurement. Noise sources can be caused by electrical or mechanical signals originating from the machine under test, nearby machinery, or the plant structure and environment. Very low frequency vibration measurements are much more susceptible to environmental noise than general monitoring.

Indirect sources: high frequency vibration noise

Indirect noise originates at high frequency and interacts with the measurement system to produce low frequency interference. Several common examples of indirect mechanical noise include pump cavitation, steam leaks on paper machine dryer cans, and compressed air leaks. These sources produce high amplitude, high frequency vibration noise (HFVN) and can overload the sensor amplifier to produce low frequency distortion. This type of interference is a form of intermodulation distortion commonly referred to as “washover” distortion; it usually appears as an exaggerated “ski slope”.⁹

Pump cavitation produces HFVN due to the collapse of cavitation bubbles. The spectrums in Figure 12 show measurements from identical pumps using a 500 mV/g low frequency accelerometer. The first plot displays expected readings from the normal pump; the second shows ski slope due to pump cavitation and washover distortion. Although cavitation overload can mask low frequency signals, it is a reliable sign of pump wear and can be added to the diagnostic toolbox.

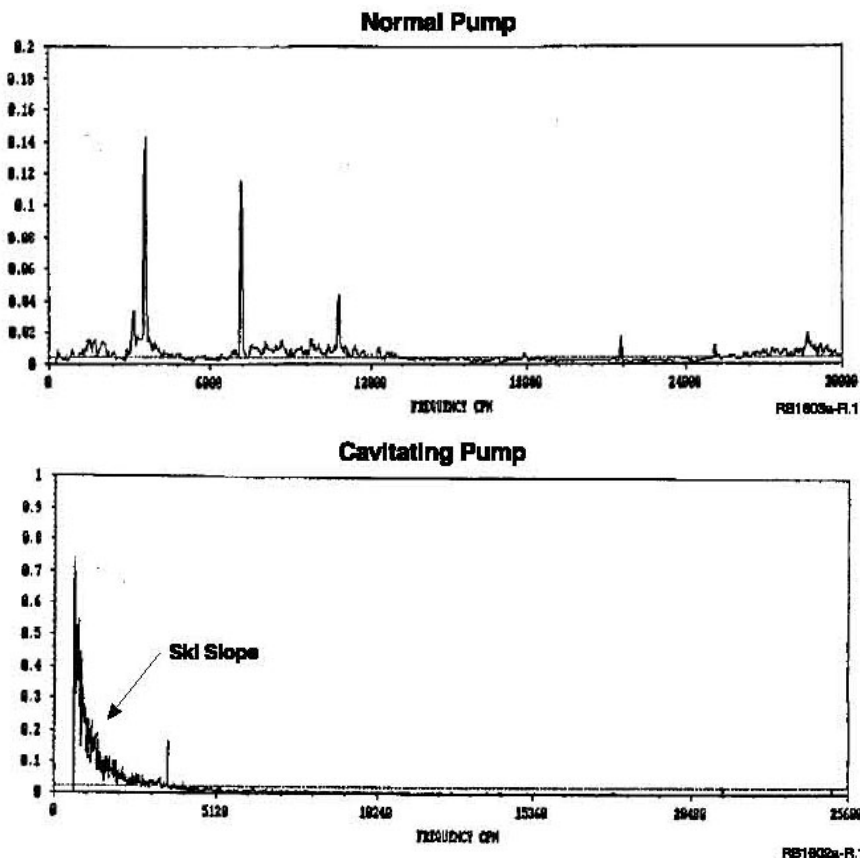



Gas leaks are another common source of HFVN. Paper machines contain steam heated dryer cans fitted with high pressure seals. When a seal leak develops, steam exhaust produces very high amplitude noise. Similar to cavitation, the “hiss” overloads the accelerometer amplifier to produce low frequency distortion. Again, this represents a real problem with the machine that must be repaired.

Low frequency accelerometers are generally more susceptible to HFVN and washover distortion than general purpose accelerometers. This is due to their lower resonance frequency and higher sensitivity. Piezovelocity transducers, where applicable, eliminate washover distortion by attenuating HFVN.

Indirect sources: electrical noise

Indirect electrical events from electromagnetic radiation and electrostatic discharge can induce noise directly into the measurement system. When mounting or cabling the sensor near radio equipment, ignition wires, or machinery with high voltage corona discharge, low frequency interference becomes a concern. Unless properly protected, the sensor amplifier can rectify very high frequency signals to produce low frequency distortion products. It is very important that overload reduction circuitry be used to prevent the sensor amplifier from operating as an AM radio detector. Anyone who has noticed automobile radio static increase with engine speed has experienced this problem.

Direct noise sources

Direct environmental noise is caused by low frequency mechanical events within the measurement region. Primary sources include thermal transient pickup and interference from unwanted low frequency vibration sources.

Thermal transients cause low frequency expansion of the sensor housing. Often mistaken for the pyroelectric effect, the resultant mechanical strain signal is transmitted to the piezoelectric sensing element. Susceptibility to false signals from thermal transients is directly related to the strain sensitivity of the sensor and filter corner frequency. Low frequency sensors must be designed for low strain sensitivity to prevent thermal transient disturbances.

Direct vibration noise from the rumble of nearby machinery and equipment can limit low frequency measurement in many plant environments. Low frequency energy propagates easily through most structures. At very low frequencies,

passing vehicular noise will produce measurement interference. Even advanced noise isolation structures employed in laboratories can be insufficient in traffic prone areas. Some very low frequency measurements must be performed in the middle of the night!

The spectrums in Figure 13 show the influence of environmental noise on low frequency measurements. Using a 500 mV/g accelerometer and a differential input data collector, vibration measurements were made on an agitator gear reducer at a soap factory. The reducer vibration was then simulated in a laboratory on a low frequency shaker. The output shaft vibration was measured to be 2.4 mil pp at 19 cpm (.32 Hz), integration to displacement was implemented by software after the measurement. Comparison of the laboratory and plant spectrums clearly show increased noise due to the plant environment. In this application, the instrument and sensor system noise was not a measurement factor.¹⁰

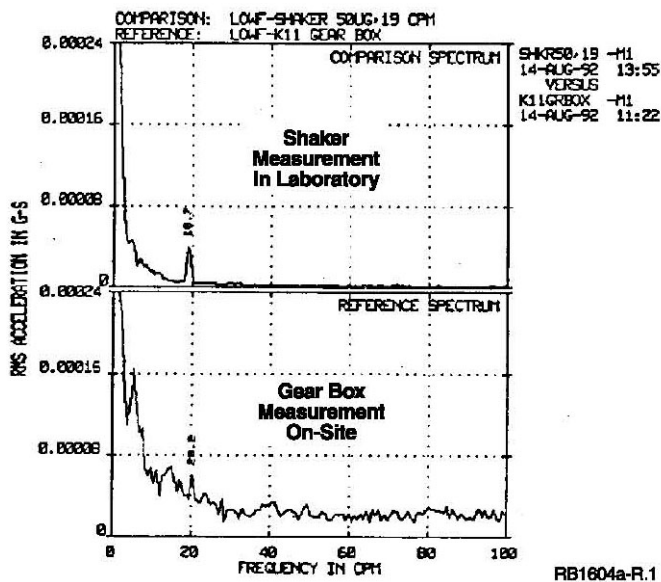

Figure 13. Comparison spectra of laboratory vs. on-site measurements



Practical measurement considerations

Measurement time considerations

Low frequency measurements are inherently slow. The time to take one average is equal to the number of lines of resolution divided by the bandwidth. A measurement resolution of 1600 lines over 0 to 10 Hz (0 to 600 cpm) bandwidth will take 160 seconds per full data set. This must be multiplied by the number of averages and any overlapping applied to find the total measurement time (refer to Table 3). Overlapping is a valuable tool that will significantly reduce data collection time. Overlapping of 50% can maintain data quality and cut measurement time by almost half.¹¹

Signal improvement is negligible after six to eight averages; however the practical limit may be the patience of the analyst. The agitator measurement above consisted of six averages over a 600 cpm (10Hz) bandwidth and 1600 lines of resolution—with auto ranging and 50% overlap the measurement took 11 minutes!¹⁰

Low frequency signals and noise may vary in amplitude and increase auto ranging time. If applicable, use live time display and manually select the proper range. Manual ranging will decrease measurement time and increase confidence in sub synchronous data.¹²

Order tracking

In low frequency applications order tracking techniques may also be required. Many slow speed machines have little rotational inertia and vary in speed over time. The variance will smear low frequency data and severely corrupt spectral resolution. Improvements in spectral noise from increased resolution will be eliminated if the smear is wider than the line width.

Triggering from the running speed and converting frequency information to orders is a powerful tool. Order tracking allows the instrument to follow speed changes and running speed harmonics. When using with waterfall plots, non-synchronous and non-harmonic signals become clearly recognizable.

Enveloping

Enveloping techniques utilize high frequency vibration noise from bearing impacts to extract bearing fault information. Repetition rate information from



paper machine rolls and felt defects are also detected. Common enveloping techniques offered are Acceleration and Velocity Enveloping, Amplitude Demodulation, Spike Energy_ Spectrum and Spectral Emitted Energy (SEE®).

Each technique uses enveloping filters to isolate a preset high frequency measurement band. HFVN from metal to metal contact within the machine assembly acts as a carrier frequency for low frequency fault signals. The enveloped HFVN is rectified to enhance the faults and then filtered to leave only the low frequency information.¹³

Turn on and settling time

Turn on and settling time are a factor in many low frequency applications. In both cases changing bias output voltage is interpreted as a very high level low frequency signal. The varying signal will delay auto ranging and may corrupt the first several data bins of the spectrum producing significant “ski-slope”.¹⁴

Turn on is the time it takes the bias voltage to power up to its final rest point. Turn on times of low frequency accelerometers vary from 1 to 8 seconds depending on design. Multiplexed powering systems utilize a time delay before data collection to eliminate spectral corruption; continuous powered applications are not a concern.

Settling time can be a much greater problem in walk around applications. Settling is the time it takes the amplifier bias voltage to recover from shock overload; low frequency accelerometer recovery may vary from 2 seconds to 5 minutes! The problem is most evident when using magnets at low frequency. Sensors with overload protection circuitry recover from mounting shock much faster than unprotected sensors. Due to the high sensitivity of low frequency sensors, unprotected amplifiers are also at risk of permanent damage from shock overload.

Mounting

Stud mounts are recommended for low frequency measurements. Use of magnets and probe tips allow the sensor to move at low frequency and disturb the measurement. Handheld measurements can be disturbed by movement of the operators hand (the coffee factor) and cable motion. Stud mounts firmly attach the sensor to the structure and ensure that only vibrations transmitted through the machine surface are measured. Handheld mounts also exhibit lower mounting resonances and may be more susceptible to HFVN distortion.



Low frequency applications

Bearing monitoring

Roller element bearings are often used on very slow speed machinery such as paper machine rollers, agitators and stone crushing equipment. Turning speeds on some machines may be as low as 0.2 (12Hz).

Generally fault frequencies are at higher frequencies and well within the measurement capabilities of most systems. However 1x, 2x, and 3x running speed information is important in diagnosing unbalance, misalignment, and looseness. Instruments must be able to trigger at slow speeds for order tracking and synchronous time averaging applications.

Sleeve bearings are sometimes used on very slow speed machinery. Crank bearings on large stamping machines may operate as low as .18 Hz (11 cpm). Bearing wear and clearance increases can cause looseness and may be appear at 2x crank speed. Oil whirl instability vibrations occur at .42-.48x running speed.

Gear subharmonics

Gear monitoring is generally considered a high frequency application. However, recent studies of spectral information below gear mesh frequency has shown a strong correlation between gear mesh subharmonics and gear tooth faults and wear. Low frequency gear mesh subharmonics, like roller bearing fault frequencies, are not natural vibrations - they are only present when there exists a flaw or developing fault.

Subharmonic mesh vibrations are related to hunting tooth problems as faulty gear and pinion teeth contact each other. Hunting tooth frequencies (f_{HT}) can be calculated using the following equation:

$$f_{HT} = (f_{GM})(N_A)(T_{GEAR})(T_{PINION})$$

Where:

f_{GM} = gear mesh frequency (pinion gear x gear teeth)

N_A = number of unique assembly phases

T_{GEAR} = number of gear teeth

T_{PINION} = number of pinion teeth

The number of unique assembly phases (N_A), is equal to the products of the prime factors common to the number of teeth on each gear in the mesh.¹⁵ For

example: Given a pinion with 18 teeth, the number 18 is the product of prime numbers $3 \times 3 \times 2$. And given a mating gear with 30 teeth, the number 30 is the product of $5 \times 3 \times 2$. The prime numbers shared between the pinion and the gear are 2 and 3; the product of shared prime numbers (N_A) is 6. If on a reducing gear the input drive speed was 900 cpm (15 Hz), the gear mesh equals 27,000 cpm (450 Hz).

The hunting tooth fault frequency in this example is:

$$(15\text{Hz})(6) (30) (18) = .83\text{Hz} (50\text{cpm})$$

The hunting tooth frequency for a true hunting tooth gear set, ($N_A = 1$), is the pinion speed divided by the number of gear teeth (or visa versa, gear speed/ T_{PINION}).

Cooling towers

Cooling towers are used throughout the power generation and process industries. They are constructed of a motor driven shaft coupled to a reduction gear driven fan. The fan is perched atop a large venturi tower through which water is passed and cooled (Figure 14). Catastrophic cooling tower failure from damaged gears and blades can result in lost production and high repair costs.

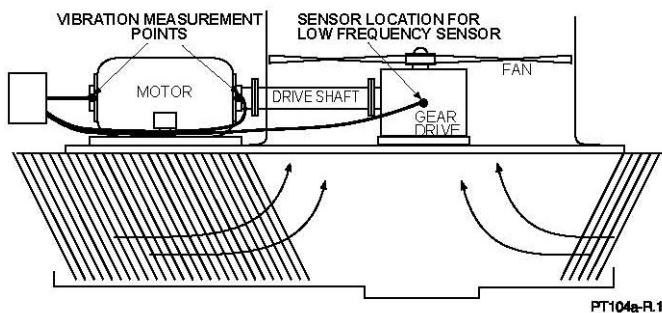



Figure 14. Critical sensor points for cooling towers

Traditional cooling tower monitoring consists of vibration switches or periodic accelerometer measurements on the motor. Vibration switches are extremely unreliable in shutting down a damaged machine. Periodic measurements, while adequate for bearing and coupling condition at the motor, give little information about the gear box and fan. Proactive cooling tower monitoring requires permanent low frequency sensors mounted on the gear box.¹⁶

Cooling towers exhibit three challenges to permanent sensing systems; a wet corrosive environment, very slow rotational speeds, and a variety of support structures and rigidities.¹⁷ Fans speeds may range from 1.5 to 15 Hz (90 to 900 cpm) with predominate fault frequencies at 1x (unbalance) and 2x (looseness).



Developing fan faults such as cracks will be apparent at the blade pass frequency (typically 4x).

The recommended vibration limit on the fan is 9.5 mils peak-to-peak. Given a fan speed of 150 cpm (2.5Hz), 1x alarm amplitudes produce little velocity (.075 ips) and even less acceleration (.003 g).¹⁸ Use of a low noise 500 mV/g piezoceramic accelerometer or a low frequency piezovelocity transducer (PVT) is recommended for most cooling tower installations.

The plots below show the effects of sensor and instrument noise on low frequency measurements. The spectrums were taken with a variety of sensors on a steel industry cooling tower. The fan speed was 118.69 CPM (1.98 Hz) with a 1x amplitude of .02 ips or .00065 g. The spectrum in Figure 15a shows the cooling tower vibration measured by a 25 mV/ips low frequency PVT.

No ski slope is visible because of the following:

- 1) the low noise electronics of the PVT ($275 \mu\text{ips}/\sqrt{\text{Hz}}$, S/N = 70)
- 2) the high voltage output to the instrument (.02 ips x 25 mV/ips = .5 V)
- 3) the high pass filter in the sensor (-3dB corner frequency = 0.7 Hz, 42 cpm)

The spectrum in Figure 15b shows the same point measured by a 500 mV/g low frequency piezoceramic accelerometer. The small ski slope is due to the monitoring instrument because of the following:

- 1) the low noise electronics of the accelerometer ($2 \mu\text{g}/\sqrt{\text{Hz}}$, S/N=325)
- 2) the moderate voltage output to the instrument ($650 \mu\text{g} \times 500 \text{ mV/g} = 325 \mu\text{V}$)

The final spectrum in Figure 15c shows the point measured by a 500 mV/g quartz accelerometer. The larger ski slope is due to the sensor amplifier noise because of the following:

- 1) higher electronic noise of quartz sensors (exact value unknown)
- 2) same voltage output to the instrument as in Figure 15b.

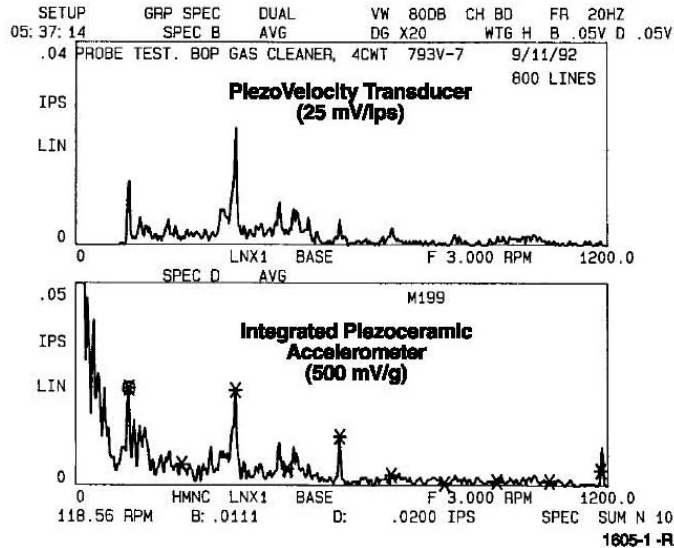

Figures 15a and 15b. Low frequency integration noise comparing a piezovelocity transducer to a piezoceramic accelerometer

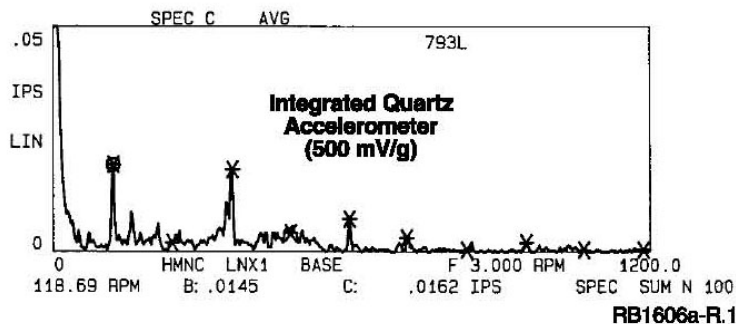

Figure 15c. Low frequency integration noise comparing a piezovelocity transducer to a quartz accelerometer

Conclusion

Low frequency condition monitoring requires strict attention to selection and use of vibration measurement equipment. The low acceleration amplitudes on slow speed machinery are beyond the measurement limits of general instrumentation and techniques. Concerted efforts to improve the signal to noise ratio of the measurement are required to best utilize data collection time and effort.

Specially designed low frequency piezoceramic sensors are recommended in most applications. Piezoceramic transducers provide superior performance over the broad frequency and amplitude ranges required in industrial applications.



They employ low noise electronics, provide high outputs to the instrument, and resist environmental effects.

Instruments must be chosen with low frequency input capability and ample dynamic range. Proper instrument design and set up lowers system noise and speeds data collection time. Special techniques can be used to further improve data reliability.

Low frequency applications and techniques are continually being discovered and refined. A systematic approach toward low frequency condition monitoring helps ensure that program goals are met.



Bibliography

1. Barrett, Richard, "Industrial Vibration Sensor Selection: Piezo-Velocity Transducers (PVT)", Proc. 17th annual meeting, Vibration institute, June 1993, p135-140.
2. Schloss, Fred, "Accelerometer Overload", Sound & Vibration, January, 1989.
3. Druif, Dave, "Extremely Low Frequency Measurement Techniques", Test Report, Computational Systems Incorporated, 1992.
4. Grant, Douglas C., "Low Frequency Performance of Piezoelectric Accelerometers", Proc. 14th annual meeting, Vibration Institute, June 1990, p89-92.
5. Technology for Energy, "Very Low Frequency Data Collection", TEC Trends, Jan/Feb 1993.
6. Schloss, Fred, "Accelerometer Noise", Sound & Vibration, March 1993, p22-23.
7. Robinson, James C.; LeVert, Francis E.; Mott, J.E.; "Vibration Data Acquisition of Low Speed Machinery (10 rpm) Using a Portable Data Collector and a Low Impedance Accelerometer", P/PM Technology, May/June 1992, p32-36.
8. Judd, John E., "Sensor Noise Considerations in Low Frequency Machinery Vibration Measurements", P/PM Technology, May/June 1992, p26-30.
9. Computational Systems, Inc., "Selection of Proper Sensors for Low Frequency Vibration Measurements", Noise & Vibration Control Worldwide, October 1988, p256.
10. Seeber, Steve, "Low Frequency Measurement Techniques", MidAtlantic Infrared Services.
11. Chandler, John K., "Overlap Averaging: A Practical Look", Sound & Vibration, May 1991, p24-29.
12. Shreve, Dennis, "Special Considerations in Making Low Frequency Vibration Measurements", P/PM Technology, April 1993, p18-19.
13. SKF Condition Monitoring, "Acceleration Enveloping in Paper Machines", Application Note CM3024-EN, April 1993.
14. Robinson, James C. LeVert, Francis E.; Mott, J.E.; "The Acquisition of Vibration Data from Low-Speed Machinery", Sound & Vibration, May 1992, p22-28.
15. Berry, James E., "Advanced Vibration Analysis Diagnostic & Corrective Techniques", Discussion of vibration diagnostic chart, Piedmont Chapter #14 of Vibration Institute, Technical Associates of Charlotte, Inc., May 27, 1993.
16. Croix, Rick; Suarez, Steve; Crum, Coco; "Monitoring Systems for Cooling Tower and Process Cooler Fans", DataSignal Systems Technical Bulletin.
17. Bernhard, D.L., "Cooling Tower Fan Vibration Monitoring", IRD Mechanalysis, Cooling Tower Institute 1986 Annual Meeting, January 1986.
18. Murphy, Dan, "Cooling Tower Vibration Analysis", The Marley Cooling Tower Company, Maintenance Technology, July 1991, pp29-33.



Use of vibration alarm levels in sensor selection

Vibration alarm levels can be used to determine the minimum levels of amplitude resolution required by low frequency measurement equipment. Alarm levels define the maximum acceptable vibration amplitude over a preset frequency band. Machinery operating above alarm is considered to be in immediate danger of failure.

Vibration amplitudes below alarm are trended to predict machinery health. Alarm bands should be determined empirically using statistical knowledge of the machinery under test^a. However, in most cases simplified guidelines are used in place of statistical analysis. Traditionally, vibration alarm levels were written in terms of velocity, without regard to machine speed.

The industry standard 0.3 ips alarm has been used for many years on bearings, gears and other machinery. However, since displacement is the predominant form of destructive motion at low frequency, this guideline is inadequate for slow speed machinery. A slow speed 9.5 mils pp alarm level is recommended for machinery operating below 10 Hz (600 cpm). The displacement alarm can be normalized in terms of velocity by using the equation below^b:

$$A_l = A_s (f_l/600\text{cpm})$$

Where:

A_l = low frequency alarm level

A_s = standard alarm level (usually 0.3 ips)

f_l = low frequency point of interest in cpm



Table A gives alarm levels in terms of velocity, displacement and the equivalent acceleration produced at these levels.

Table A. Vibration amplitudes at standard alarm limits

Frequency cpm (Hz)	Displacement mils pp	Velocity Alarm Level ips	Acceleration g
6 (.1)	9.5	.003	.000005
12 (.2)	9.5	.006	.000020
30 (.5)	9.5	.015	.000120
60 (1.0)	9.5	.03	.000490
90 (1.5)	9.5	.045	.0011
120 (2)	9.5	.06	.002
300 (5)	9.5	.15	.012
600 (10)	9.5	.3	.050
1,800 (30)	3.2	.3	.150
3,600 (60)	1.6	.3	.2
7,200 (120)	.80	.3	.5
60,000 (1,000)	.095	.3	5.0

This chart can be used to specify the absolute minimum low level detection capability of the sensor/instrument system. Obviously most analysts want trend data long before alarm, therefore final sensor selection must be based on the specific requirements of the application.

Bibliography

- a. Wetzel, Richard L., "Statistical Alarm Methods", P/PM Technology, 1990.
- b. Berry, James E., P.E., "Required Vibration Analysis Techniques and Instrumentation on Low Speed Machines (Particularly 30 to 300 RPM Machinery" 2nd Edition, Technical Associates of Charlotte, Inc, 1992, p46-47.